

# **A study of CO oxidation in Intermediate Temperature SOFCs**

Gregory J Offer  
Nigel P Brandon

# Why SOFCs

- Near term gains in energy efficiency
  - Generating both hot water and electricity from the same amount of gas we currently use for just hot water
  - High value heat generated
- Low cost catalysts
- Low cost fabrication procedures

# Rationale

- CO oxidation kinetics necessary for modelling work
  - CO oxidation has only been reported in the literature at 700°C or above
  - Typically 3 times slower, is this true <700°C
- Understanding carbon deposition is important
  - Thermodynamic predictions are limited and an understanding of the kinetics are needed
  - Carbon deposition by the Boudouard reaction ( $2\text{CO} \rightarrow \text{C} + \text{CO}_2$ ) can be assessed using dry CO
- Accelerated degradation tests are necessary in order to test new materials
  - Need to develop methodologies for testing new/existing materials under harsh conditions
- Contamination is one of the major challenges for SOFC commercialisation
  - C<sub>2</sub>+ hydrocarbons and sulphur compounds are major contaminants in natural gas

# Experiments

- Ni/CGO:CGO:LSCF/CGO pellets
- 500, 550 and 600°C
- 0, 50, and 100 mA cm<sup>-2</sup>
- Exposed to dry CO for 1 hour
- Characterisation on dry H<sub>2</sub> before and after
- EIS experiments throughout exposure

# Apparatus

- Three electrode design with ring disc cathode
- Standard conventions on correct placement of reference electrode followed
- A correction procedure to subtract electrochemical performance from polarisation curves was used \*

\* Offer, G.J., et al., *Using electrochemical impedance spectroscopy to compensate for errors when measuring polarisation curves during three-electrode measurements of solid oxide fuel cell electrodes*. *Electrochimica Acta*, 2008, Vol: 53, Issue: 26, Pages: 7614-7621

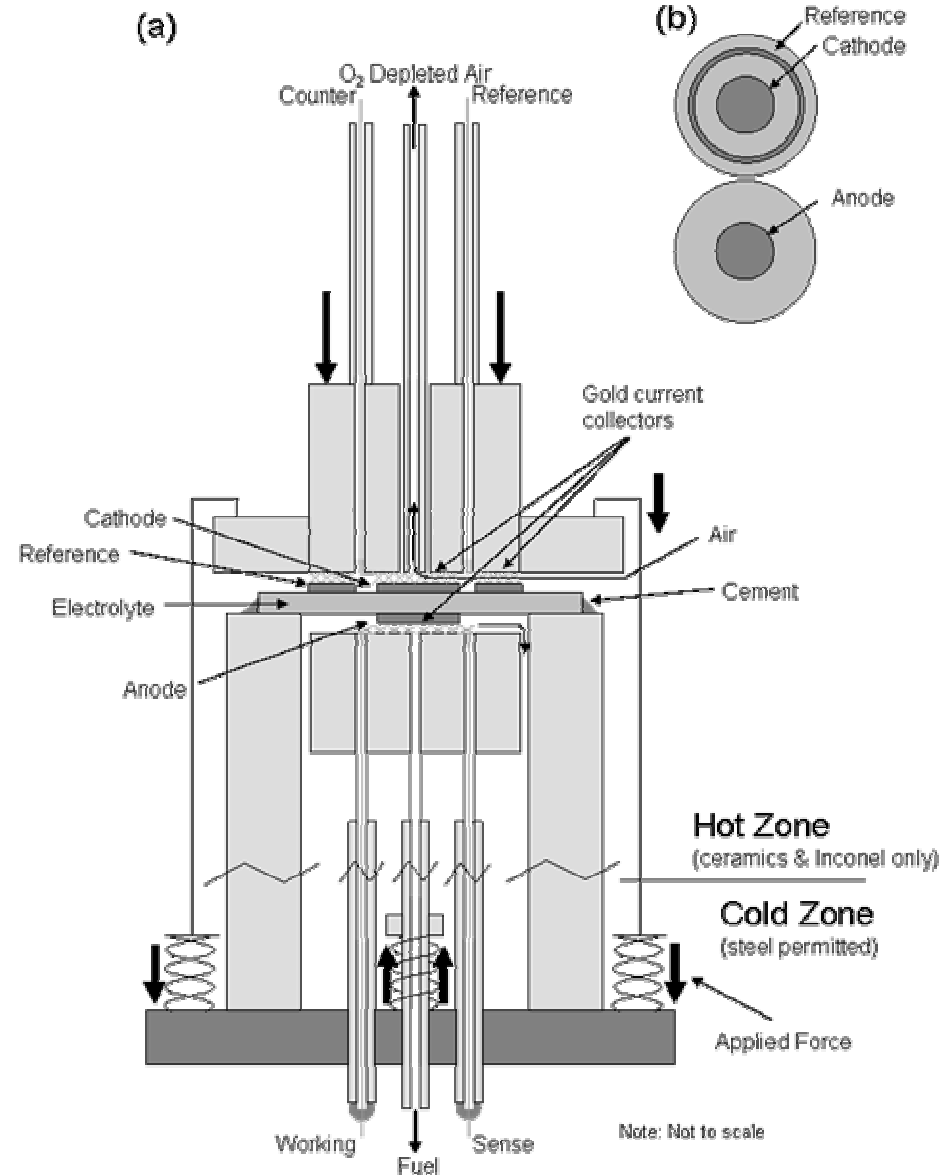

# Visual Inspection

- Flow Channel effect
- Obvious signs of carbon deposition
  - Numerous features of interest
- Obvious signs of anode erosion
- Some delamination

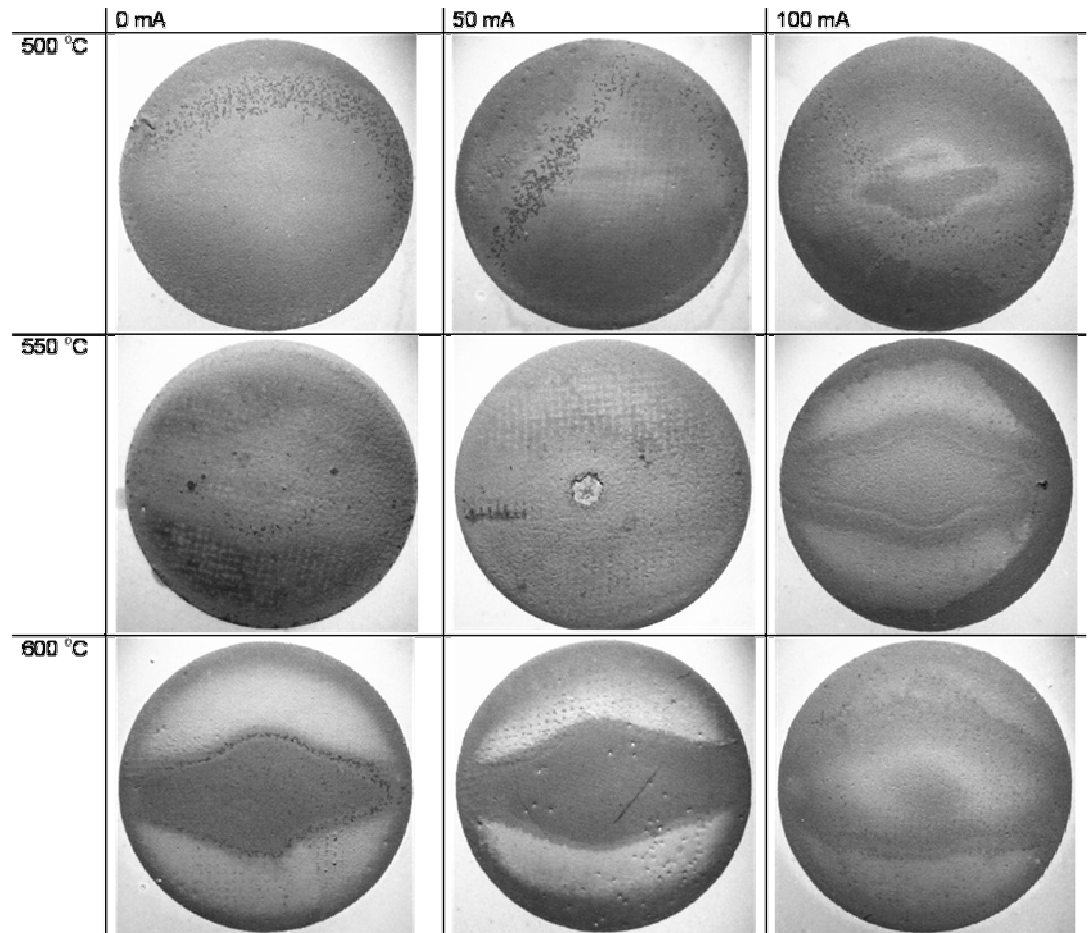

Images of the nickel cermet electrodes after testing on carbon monoxide for 60 minutes at different temperatures and currents

# Overpotential during testing

- Continual degradation in performance
- Caused by both
  - Carbon deposition
  - Slower COOR kinetics
- Need to isolate these effects
- Leakage current in CGO generates defined OCP even in dry conditions

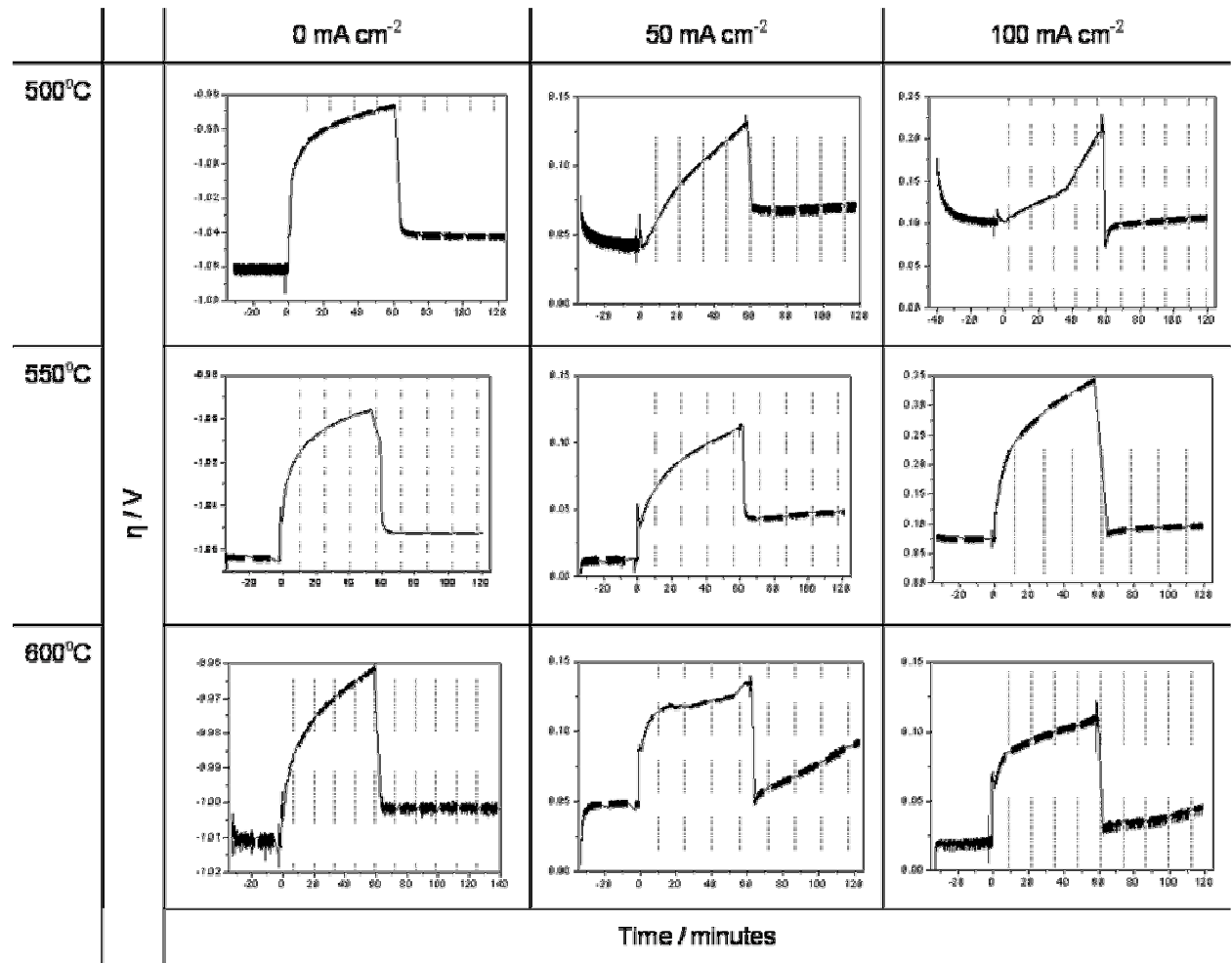

Graph showing the changes in performance during testing of the anodes at 500, 550, and 600°C and at 0 mA cm<sup>-2</sup>, 50 mA cm<sup>-2</sup>, and 100 mA cm<sup>-2</sup>. The cell was exposed to CO at zero minutes and returned to dry H<sub>2</sub> at 60 minutes, the dotted lines indicate when the EIS measurements were taken

# Example EIS

- Difficulties in interpreting EIS with CGO pellets
- However it is clear that the low frequency arc gets bigger over time when exposed to CO
- This has been attributed to surface diffusion\*
  - Probably carbon deposition on the surface
- The EIS spectra returns to normal on H<sub>2</sub>

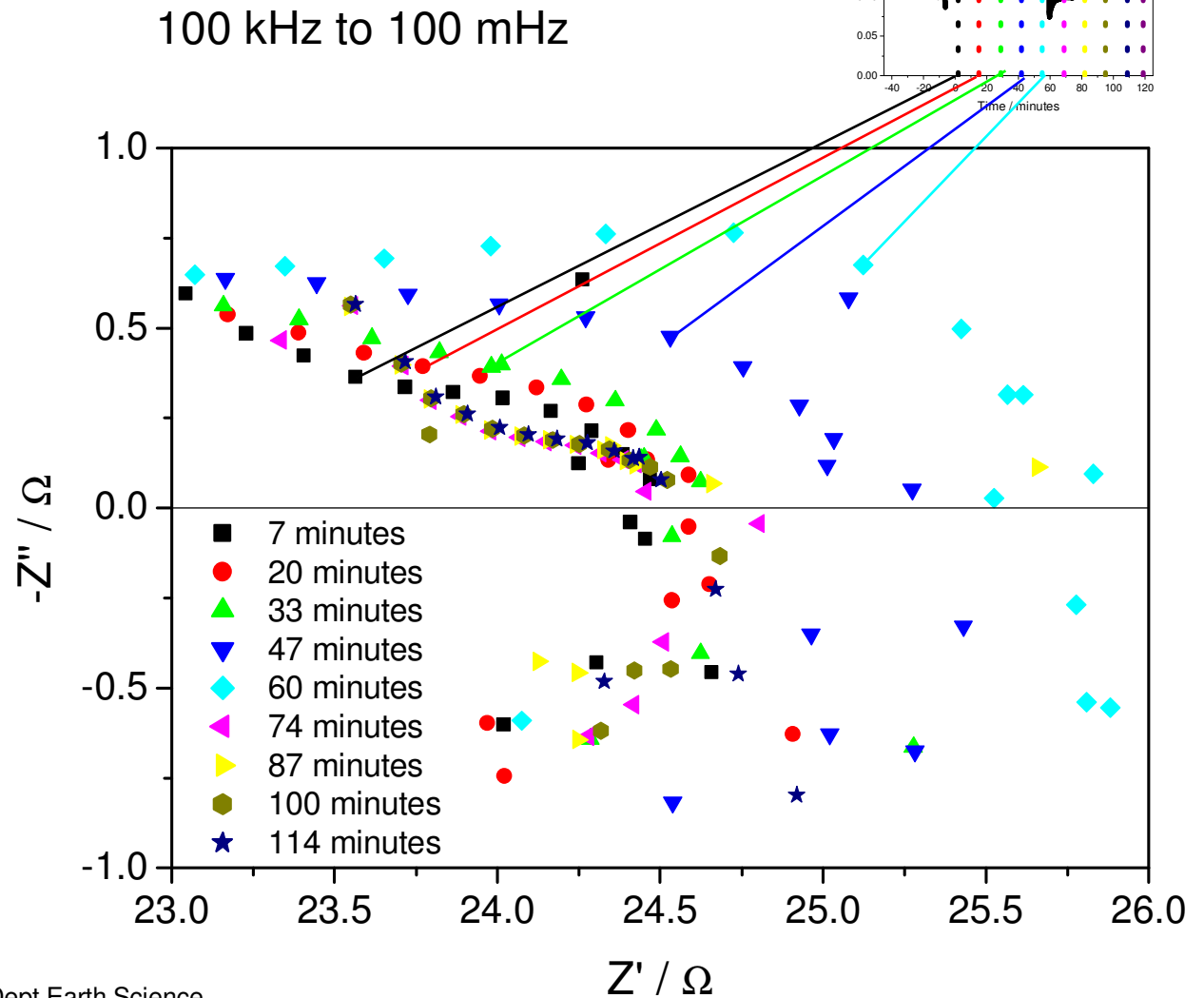

\* Lohsoontorn, Pattaraporn, in PhD thesis, Dept Earth Science Engineering, Imperial College London, 2008, supervisor Brandon, N.P.

Example EIS spectra taken during and after exposure to CO for 1 hour at 500°C and 100 mA cm<sup>-2</sup>, spectra were taken every 10 minutes and took approximately 3 minutes to collect, time zero was the initial exposure to CO.



# Before and after comparison

- Electrochemical performance of anode running on dry H<sub>2</sub>
- Excluding changes in series resistance
  - Correction procedure applied
- Key point: Isolating electrochemical performance from other degradation effects

Graphs showing the exchange current density for hydrogen oxidation of the anodes before and after exposure to dry CO for an hour at difference current densities at 500, 550 and 600oC

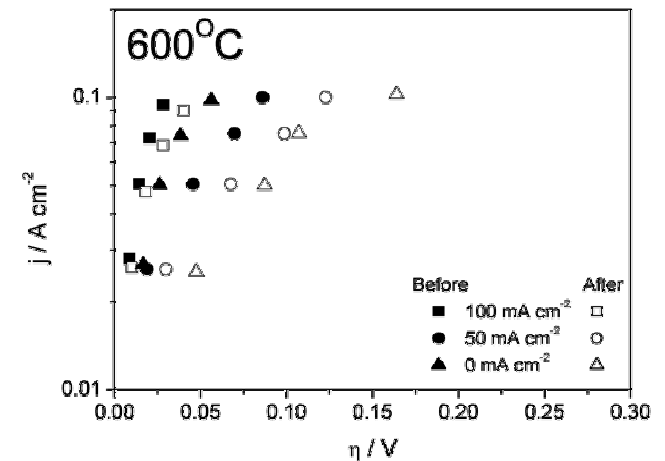
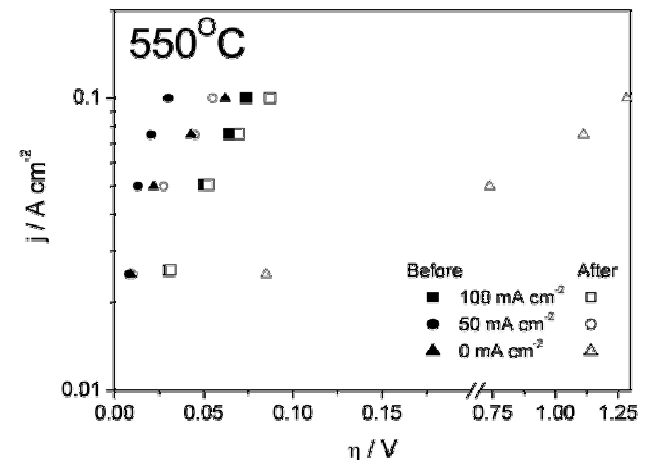
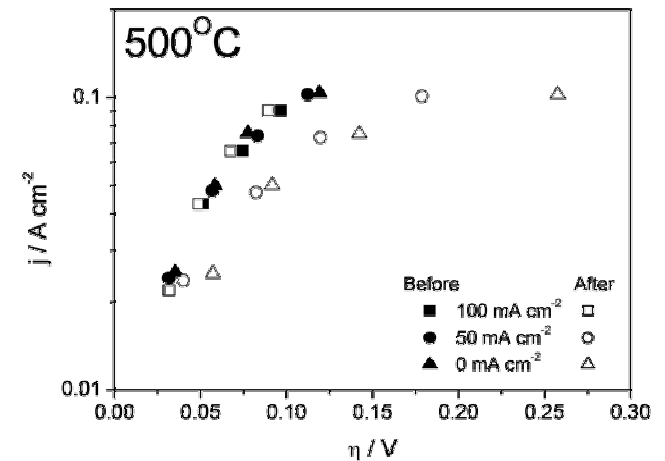

# Electrochemical Degradation

- Results fitted using Butler-Volmer equation

$$j = j_0 \left( \exp\left(\frac{\alpha F}{RT} \eta\right) - \exp\left(\frac{-(1-\alpha)F}{RT} \eta\right) \right)$$

- Charge transfer resistance calculated from exchange current density

$$R_{ct} = \frac{RT}{Fj_0}$$

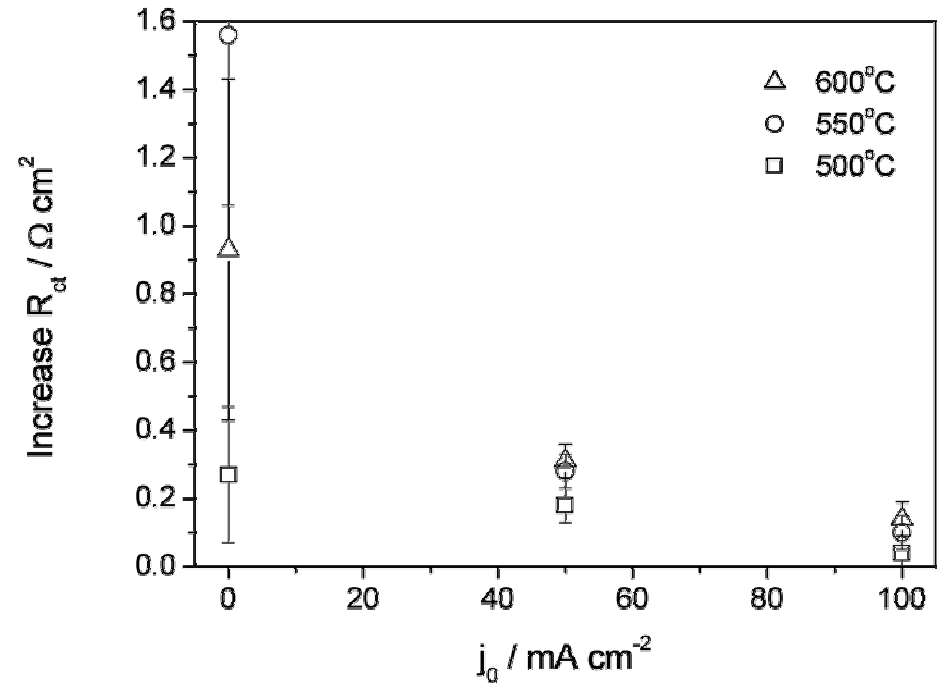

Graph showing the increase in charge transfer resistance versus current density during exposure for hydrogen oxidation of the anodes after exposure to dry CO for an hour at 500 (■), 550 (●), and 600°C (▲). The background degradation rate is approximately  $0.01 \Omega \text{ cm}^2 \text{ hour}^{-1}$ .

# Non-Electrochemical Degradation

- Series resistance
  - Unclear trends
  - Slow progressive degradation at all current densities
  - Rapid degradation upon switching to  $H_2$  except at  $100\text{ mA cm}^{-2}$
- Polarisation resistance
  - Follows trend for I-R data
  - $R_p$  increase broadly matches  $R_{ct}$  increase calculated from polarisation curves
- Conclusion
  - Need faster multi-frequency FRA

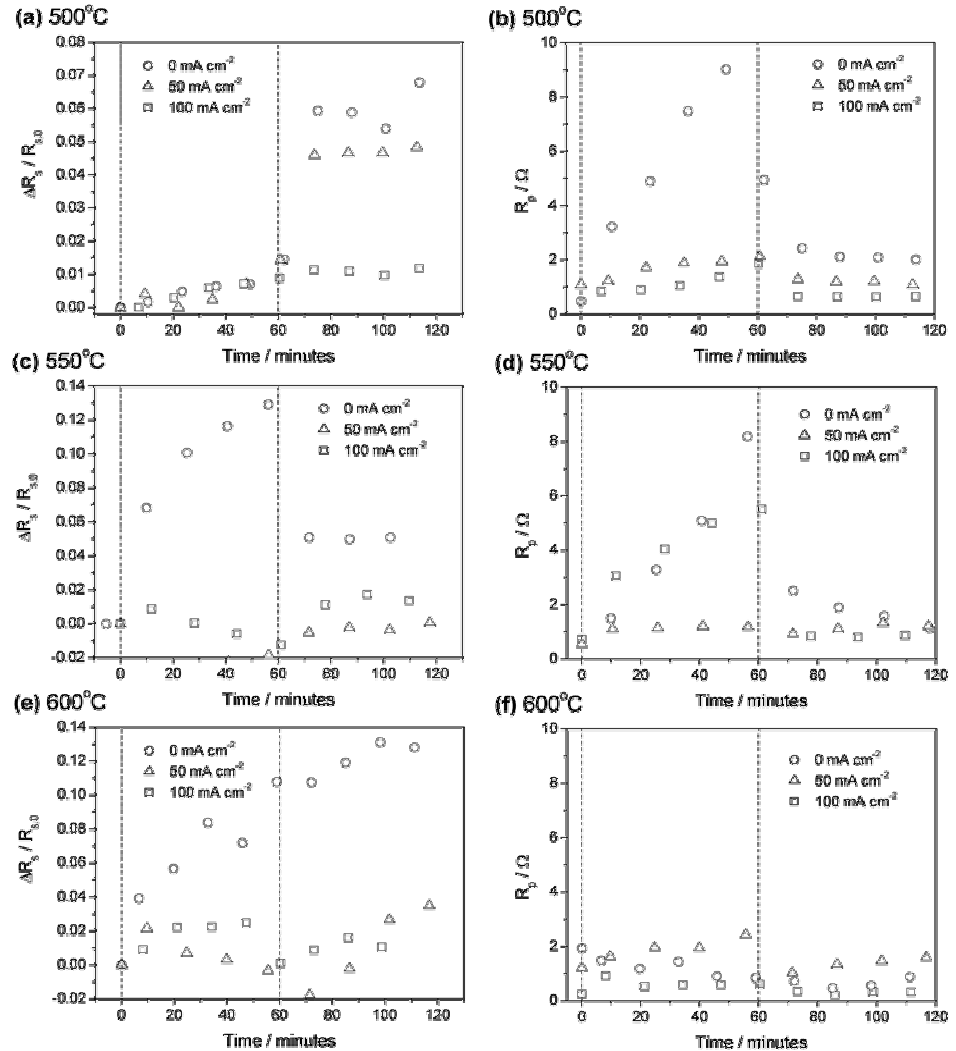

Graphs showing the changes in series and polarisation resistances of the anodes at  $500^\circ\text{C}$  and at  $0\text{ mA cm}^{-2}$  ( $\circ$ ),  $50\text{ mA cm}^{-2}$  ( $\Delta$ ), and  $100\text{ mA cm}^{-2}$  ( $\square$ ). The cell was first exposed to CO at zero minutes and the dotted line at 60 minutes represents the time when the CO was switched back to  $H_2$ .

# Conclusions

Relevant to: Nickel CGO cermet anodes

- The effect of both temperature and current upon carbon deposition from exposure to dry CO is significant.
- Carbon formation damages the anode, when it is removed, whereupon large changes can occur to the anodes resulting in irreversible damage to performance.
- By operating at 500°C at a current density of 100 mA cm<sup>-2</sup>, damage to the electrochemically active region of the anode can be prevented. Kinetics are more important than Thermodynamics
- However, damage to the non-electrochemically active region still occurs.
- The ability to decouple the effect of carbon deposition on the electrochemical and non-electrochemical performance of the anode has been demonstrated.

# Further work

- Ex-Situ Analysis

- Raman, transverse across flow channels, type and location of carbon (collaboration Rob Maher, Dept Physics)
- SEM/TEM imaging, type and location of carbon, and microstructural information of anode (with Christos Kalyvas)
- Repeats in cross section of anode, information on depth profile of anode
- TPO to confirm types of carbon, verification of types of carbon present

- In-Situ Analysis

- Raman, observe: carbon species forming, redox changes

- Impedance

- Multi-frequency impedance analysis
- Using YSZ substrate to mitigate mixed conductivity which complicates spectra
- Use defined CO/CO<sub>2</sub> mixtures in non damaging conditions

# Related work in our group (part of a bigger picture)

- Prof Nigel Brandon Group (ESE)
  - Study of TPB Distribution and Percolation in Composite Electrodes, and 3D Reconstruction of SOFC Electrodes Using Focussed Ion Beam Techniques, Paul Shearing and Joshua Golbert
  - The Impact and Mitigation of Carbon Formation on Ni-YSZ Anodes from Biomass Gasification Tars, Joshua Mermelstein
  - A Study of the Impact of Sulphur on the Performance of Intermediate Temperature Solid Oxide Fuel Cells with Nickel Gadolinium Doped Ceria Anodes, Edward Brightman and Dan Brett

Shearing, P., Golbert, J., Brandon, N. P.

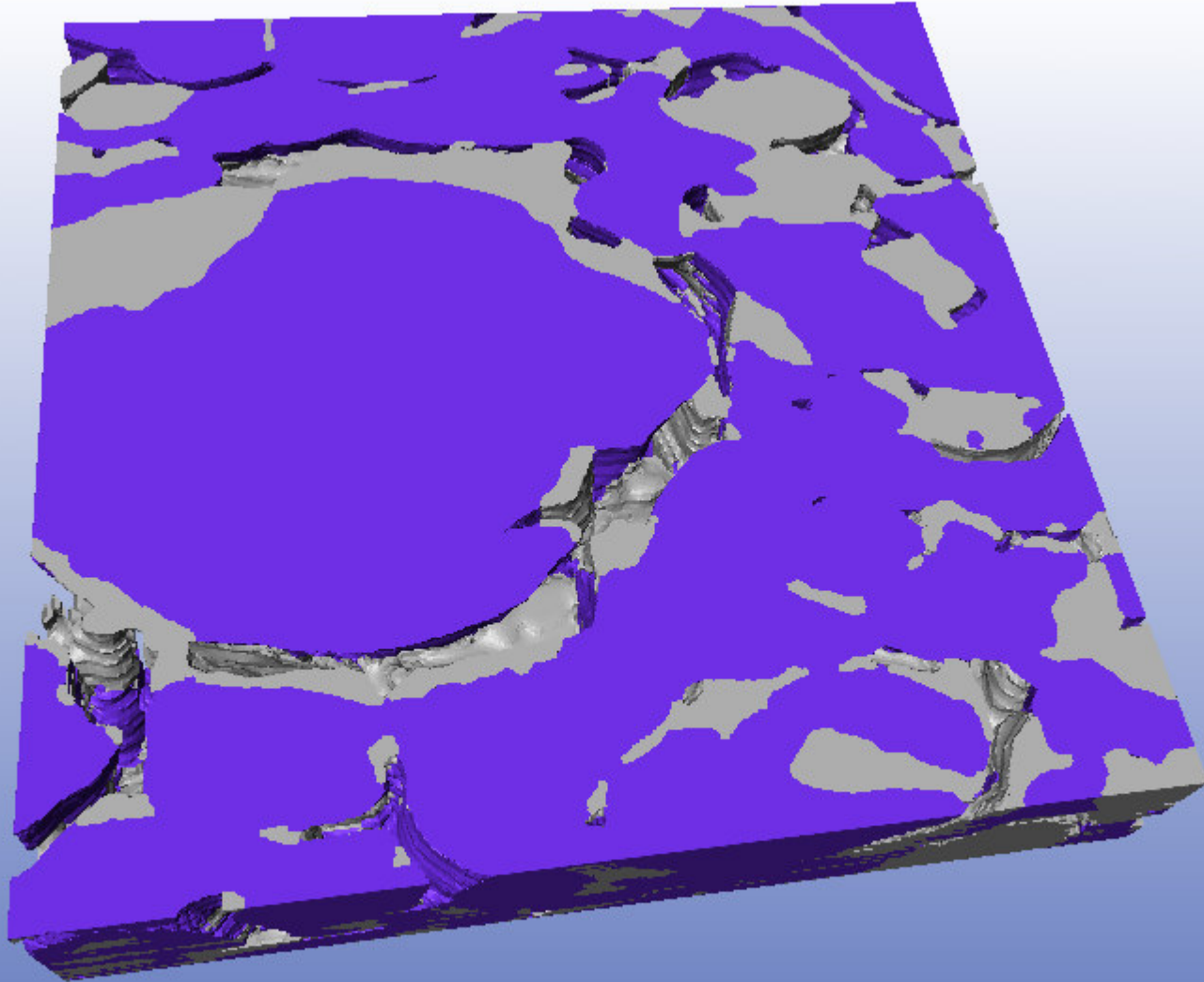

2e+03 [nm]



